

INSTRUCTION FOR INSTALLATION AND USE



Infrasauna AMBRE

Sauna: Discover the spell of
the relaxation and health

The pictures show in this handbook need not always correspond to the particular embodiment; their purpose of to assist better understanding of the textual instruction.

The manufacturer and the supplier reserve the right for product changes without the obligation to update this Instruction for Installation and Use.

Safety Information

- 1.** Before first use of your sauna please read carefully all the instructions included in this hand book and observe them.
- 2.** Installation and use of this electrical equipment requires permanent compliance with the related basic safety measures. Use a power socket for this appliance powering installed pursuant to applicable technical standards and provided with a circuit breaker with the corresponding current value and characteristics. It is also recommended to equip the power input with a current protector with the permitted current not exceeding 30 mA, especially in cases of installation in bathrooms or other wet rooms.
- 3.** Do not use your sauna in a close proximity to water, such as close to a bathtub or on a wet ground or near a pool etc.
- 4.** The power cable should be laid to prevent stepping on or squeezing between elements placed on or against it. Assure proper protection of the power cable, do not lay it straight on the ground, which is dangerous. When unused, pull the sauna power cable out of the socket and wind it. Disconnect the power cable by pulling the fork, not the rod. Otherwise the cable or the socket might get damaged.
- 5.** Before every start of the sauna check it for signs of damage and presence of objects inside.
- 6.** **Warning:** Do not touch the heating radiators while operating the sauna, their surface temperature exceeds 70°C and contact with their surface may cause burns. Do not over the heaters, risk of fire.
- 7.** In the case of the need for any part replacement, satisfy yourself that the spares are specified by the manufacturer or have the same characteristics as the original parts. Use of unauthorised spare part may cause fire, electrical shock or another hazard. After repair ask the service technician for safety checks to assure correct operable condition of the sauna, only then you can use it again.
- 8.** The equipment is not designed for the use by persons (including children) with reduced physical, sensory or mental capacities, unless a supervision and training by a qualified person is provided; persons not familiar with the operation in the scope of this manual; persons under the influence of drugs, intoxicating substances etc., reducing the capability of quick reaction.
- 9.** Do not use the sauna immediately after intensive physical exercise. Wait for at least 30 minutes to permit your body cool down properly.
- 10.** **Risk of overheating.** Normal body temperature should not rise above 39°C (103°F). Symptoms of body overheating include vertigo, lethargy, drowsiness and faintness. Consequences of body overheating may include inability to perceive heat, physical impossibility to leave the sauna, unawareness of the pending risk, loss of conscience and damage to the foetus in

the case of pregnant women. Overheating increases temperature inside your body, therefore high sauna temperature setting is not recommended.

- 11.** Use of alcohol, narcotics or certain drugs before or during use of the sauna may lead to loss of conscience.
- 12.** Never fall asleep inside a working sauna.
- 13.** Do not use steam cleaners, pressure cleaners or water sprays for cleaning your sauna. Use cleaners specified for this use.
- 14.** Do not place any objects on the top or inside walls of your sauna. Do not take in pets and metal objects into the sauna. Sauna is not designed for laundry drying.
- 15.** If the power cable is damaged have it replaced immediately by the manufacturer, its representative or another qualified electrician. If the power cable is found to be too hot there may be a problem in the electrical equipment, ask the manufacturer or its representative for a check if you find this to prevent hazard.
- 16.** Do not use sauna during storm to prevent electrical shock.
- 17.** Do not switch on and off the power and the heating system to prevent damage to the electrical equipment.
- 18.** Place the cable in the socket or pull it out of the socket with dry hands only. Never touch the cable with wet hands or feet, risk of electrical shock. Do not touch the metal outlet parts or the power cable fork with your fingers.
- 19.** Do not use your sauna if the power cable or the sauna itself is damaged or operates incorrectly. Do not attempt at any repair yourself, in the case of a problem contact your dealer or the manufacturer to prevent violation of the applicable safety principles. Unauthorised intervention may invalidate manufacturer's warranty.
- 20.** Make sure the socket for sauna connection to the mains possesses sufficient parameters for the sauna operation, in the case of too low power input the socket may get overheated and cause fire.
- 21.** In the case of some sauna models with roof lights the light temperature after switching on the sauna and the lights is high. Do not touch the light to prevent skin burns. Do not touch the lights for 20 minutes after the heating stop.
- 22.** Do not pour water or other liquids onto the infra red heating units another electrical equipment and avoid hitting them with hard objects to prevent short circuit, fire or power cut.

When not to use sauna



It is recommended not to use sauna in 24 hours from exposure to UV radiation from artificial sources or sun bath.



Prescription drugs: ask your doctor or pharmacist about potential interaction of the sauna with your medication. Some drugs, such as diuretics, antihistamines, beta blockers and barbiturates may negatively affect the natural heat regulating property of human body. This category includes both prescription and some over-the-counter drugs.



Heart diseases: infra red therapy is not recommended to patients with some heart diseases including hypertension or hypotension, chronic heart failure or problems with coronary circulation. If you suffer from any of the above mentioned diseases, long exposure to increased temperatures may be dangerous for direct effects of the heat include increased heartbeat by about 10 pulses per minute (in some cases by up to 30 pulses per minute) per one degree of raise body temperature. This contraindication also applies to patients taking drugs for their blood pressure control or using pacemaker - some infra red saunas may contain magnets that may affect pacemaker operation.



Children and seniors are the two age groups for which sauna use should first be consulted with a doctor. Although sauna use is generally safe and healthy for both these age groups, body temperature rises much quicker in children than in adults and their thermal regulation property by sweating is not as developed as in the case of adults. Similarly the ability to keep the optimum body temperature and the function of the sweat glands is reduced with increasing age and that is why both these age groups require caution and consultation with a doctor before use of infra red therapy.



Joint issues: acute joint injury should not be heated in the course of the first 48 hours or until the associated reddening or swell disappears. Chronic joint swells may not react positively to sauna use.



Pregnancy: infra red sauna use during (suspected) pregnancy is not recommended. Increased body temperature may increase temperature of the amniotic fluid which in extreme cases may lead to damage to the foetus or indigenous defect development. Pregnant women may develop body overheating leading to loss of conscience more easily. The heart and the vascular system increase their performance in the case of pregnancy even under normal ambient conditions to be able to feed the developing foetus, and body overheating further increases the demand for the heart and the vascular system. This reduces bloodstream to the internal anatomies including the heart and may lead to loss of conscience.



Certain other diseases: increased body temperature may not be suitable for individuals with multiple sclerosis, systemic lupus erythematoses, diabetic neuropathy, Parkinson disease, tumours of the central nerve system or

adrenalin insufficiency (for example in the case of Addison disease). People suffering from haemophilia or bleeding episodes should also avoid sauna use for heat widens the blood vessels.

 Sauna is further not recommended to people suffering from fever or sensitive to heat. Metal screws, joint replacements and other implants usually reflect long-wave infra red radiation and therefore do not heat up. On the other hand, silicon implants absorb infra red radiation and may heat together with the surrounding tissue, but as silicon melts at temperatures over 200°C, infra red light should not have any negative effect on them. However, every patient with an implant should consult sauna use with their surgeon. Like in the case of massage sauna use is not recommended in the case of any infectious disease, under the effect of alcohol or narcotics. And like in the case of any other similar activity: If you feel discomfort inside your sauna, or even pain or worsening of your health state, leave the sauna immediately.

 **In the case of any health problems always consult sauna use with your attending physician!**

 **Caution: If your skin reddening persists for more than one day after sauna use, do not repeat sauna therapy and consult your doctor.**

Product Introduction

Infra red sauna (infrasauna) consists of a wooden cabin, ceramic or carbon infra red heaters and a control system. The wooden cabin comprises A BOTTOM PLATE, A REAR PLATE, A LEFT PLATE, A FRONT PLATE, A RIGHT PLATE, A PLATE WITH HEATER FOR THE BENCH, A BENCH, A TOP PLATE.

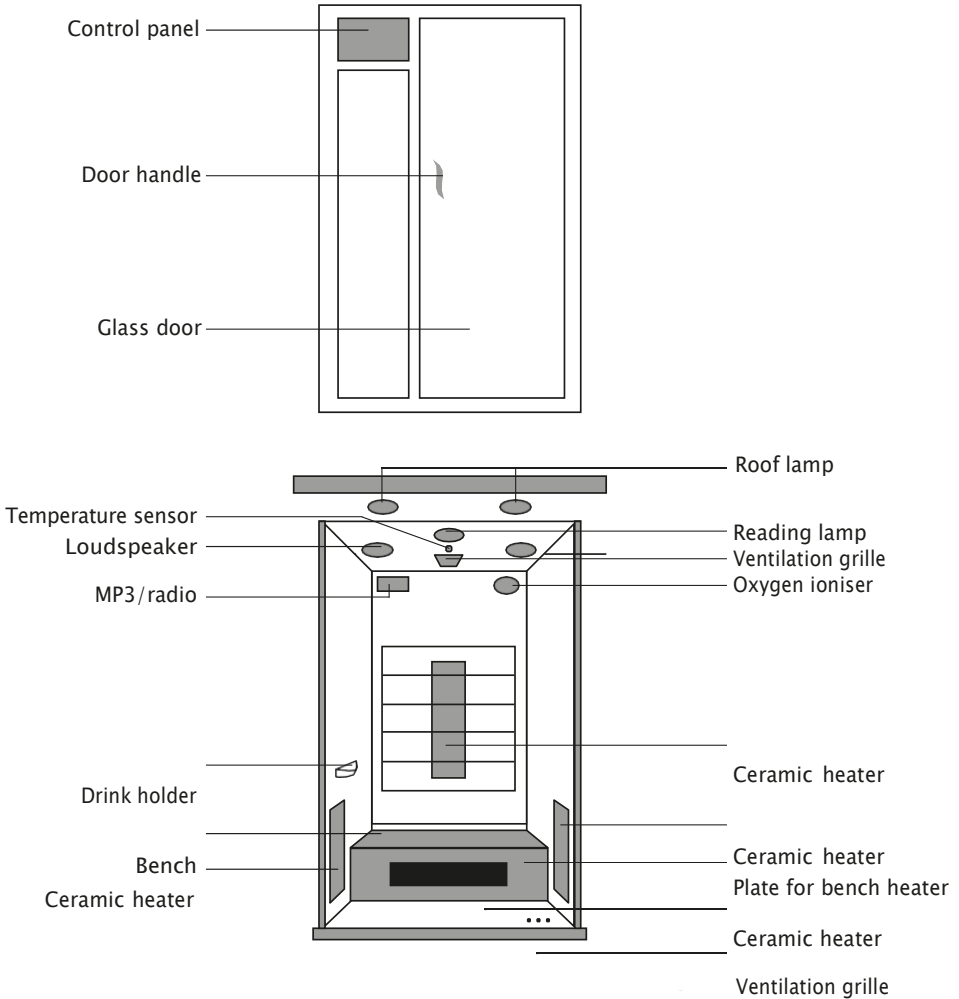

Control Cabinet

The control cabinet is the control centre of the sauna. The control cabinet is pre-installed in the TOP PLATE and only needs cable end connections.

The control is complemented by a switch and a current fuse. The control is complemented by a switch and a current fuse.

The switch must be switched on before commissioning.

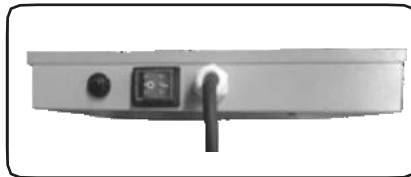
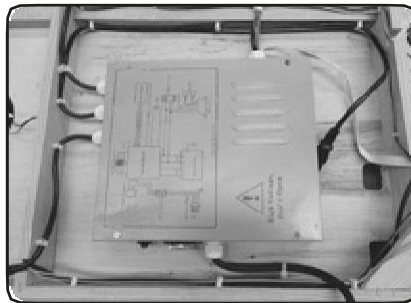

Buckle

Standard buckles for the sauna body connection

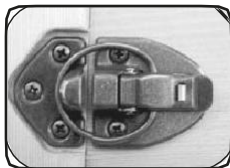

Assembly Instructions

Read the instruction for use carefully before assembly. The sauna assembly requires two adult persons.

Note: Read all instructions carefully before starting the assembly and remember to observe all applicable basic safety measures.

Find the right place for the sauna installation first.

- 1.** Sauna should be placed in a tempered space with low air humidity. Avoid sauna installation in wet spaces with poor ventilation (air circulation). sauna heating leads to humidity condensation in wet areas which may shorten life especially of electrical equipment of the sauna in the case of long-term use.
- 2.** Sauna is recommended to be installed in a space with ambient temperature of at least 15°C. Ambient temperature directly affects inside temperature of the sauna. In the case of sauna installation in a cold room its inside temperature will never reach the specified maximum values.
- 3.** Sauna must be installed on even ground. The sauna base must be flat and firm and its load-bearing capacity must suit the weight of the sauna and the persons inside it. Uneven base must be levelled.
- 4.** The sauna location must be within a safe distance from any running water source (bath tub, shower, wash basin, kitchen sink etc.).
- 5.** Close to the sauna location, i.e. Within its power cable reach, there must be an electrical inlet socket 230V/50Hz with sufficient current protection corresponding to the sauna power input - see the sauna production plate. It is also recommended to equip the power input with a current protector with the permitted current not exceeding 30 mA, especially in cases of installation in bathrooms or other wet rooms.
- 6.** The power cable must be easily accessible for quick disconnection from power in case of need.

1) REQUIRED TOOLS

A screwdriver, steps

2) ASSEMBLY STEPS

THE BOTTOM PLATE › THE REAR PLATE › THE LEFT PLATE › THE FRONT PLATE › THE RIGHT PLATE › THE PLATE WITH HEATER FOR THE BENCH › THE BENCH › THE TOP PLATE.

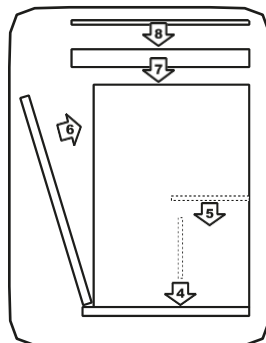
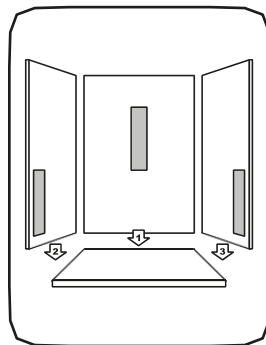

Note:

- ✓ The invisible wooden parts of the sauna may contain minor damage from the manufacture (indentations, scratches etc.) not affecting the sauna function or its outer appearance.
- ✓ Hair tears may develop in the sauna wood in the course of use. This is not product damage but natural property of the wood.
- ✓ The sauna door is not constructed for hermetic seal of the sauna. In the case of sauna use in a cold place you can provide the sauna door with appropriate seal.

A. Install the BOTTOM PLATE

Place the bottom plate on the floor. Make sure the vents in the BOTTOM PLATE are on the right front.

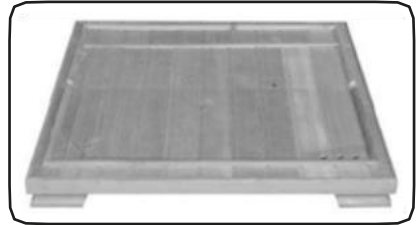

B. Install the REAR PLATE

Place the rear plate on the rear edge of the bottom plate and have somebody hold it.

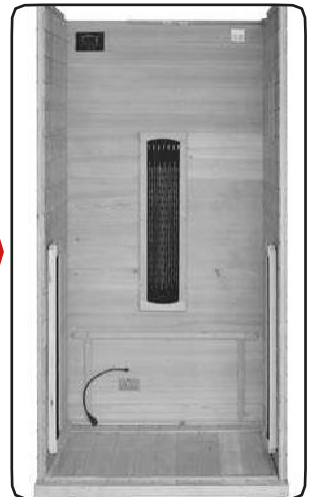
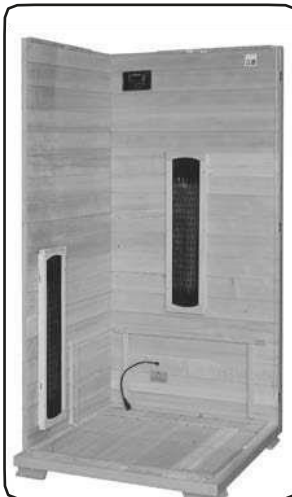
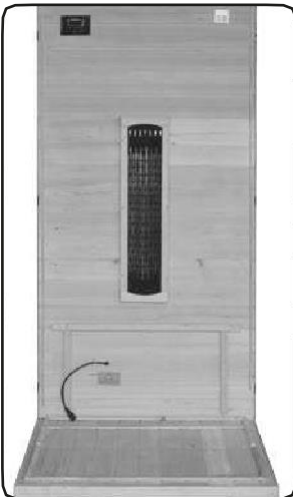

C. Install the LEFT/RIGHT PLATE

Place the left plate on the edge of the bottom plate and fix it firmly with the clasps. As soon as the left plate will be fixed in place, install the right plate in the same manner.

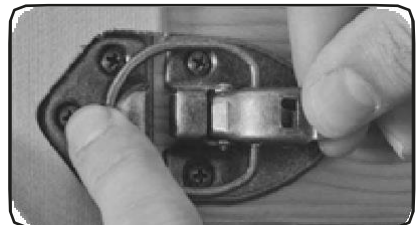

Assembly Instructions

D. Install the BENCH and the CABLE CONNECTIONS and WOODEN COVER

- Insert the Plate with the bench heating elements into the appropriate vertical grooves on each side plate. The grille of the heating element should face outwards (towards the front of the sauna). Push the Board with the bench heating elements along the full path downwards until the entire board is in full contact with the BOTTOM BOARD. Connect the bench heater connectors to the inlet located on the REAR PLATE.
- Install the bench plates by shifting them along their horizontal guides in the side plates.
- Press the benches in along their route until they contact the rear plates.
- Screw on the wooden grille.



E. Install the FRONT BOARD

Position the FRONT BOARD on the front part of the BOTTOM BOARD. Align it with the LEFT/RIGHT BOARD and secure it in place with the clasps. Install the handle in the door.



E

F. Install the TOP PLATE

The side with the CONTROL CABINET is the top side of the TOP PLATE.

The edge with the roof lights is the front of the TOP PLATE.

Note: Protect the conductors in the FRONT, REAR and SIDE PLATES against damage when installing the TOP PLATE. The holes in the TOP PLATE should be aligned with the cables along the sauna

perimeter for the conductors to be pulled through the TOP plate. Otherwise the conductors may get damaged.

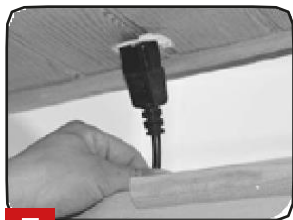

F

Pull the conductors through the holes in the TOP PLATE. As soon as all conductors are through lower the TOP PLATE in its place and make sure all holes are located correctly.



Assembly Instructions

G. Connecting TOP PLATE plugs

Connect all cables. In the case of identical connectors observe the conductor colour code.

Note: Do not plug in the power cord of the TOP PLATE during installation.

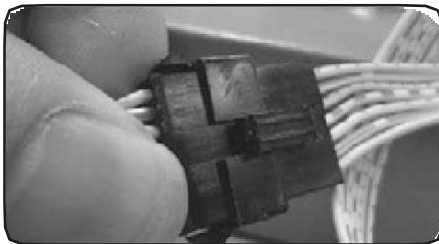
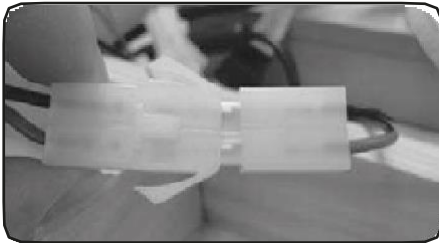

J. Install and connect the IONISER

Screw the IONISER in the right place in the REAR RIGHT PLATE and connect the power cable.



I. Install the TOP COVER

Lift the TOP COVER to the sauna top. Pull the power cord through the round hole in the TOP COVER and place the TOP COVER on the TOP PLATE. Align the TOP COVER with the TOP PLATE and screw with the bolts in the places designed for that purpose.

Note: Before installing the TOP COVER, turn on the switch on the control box



K. Screw on the DRINKS HOLDER

Use two screws to fix the DRINKS HOLDER at an appropriate place on the LEFT PLATE above the heater.

Sauna Control and Operation

Note: Before switching the sauna on check and test connections of the CONTROL BOX, the HEATERS, the MP3 PLAYER/RADIO, the TEMPERATURE SENSOR etc. and make sure the electrical power parameters and frequency correspond to the value required for your sauna. Make sure you have sufficient power input available and then switch on the sauna.

1 Connection

Plug the fork into the appropriate socket.

2 Power up

Switch the sauna on with the POWER button in the control panel on the inside or the outside wall of your sauna. The power LED control (POWER) below the display will illuminate and the sauna will start heating to the present temperature and for the preset time.

You can switch the sauna off again with the POWER button. The power will be disconnected and all lights will go off.

3 Heating Time Settings

With the sauna on you can use the + and - (Time) buttons to increase or decrease the sauna heating time. One depression of the button will increase/decrease the time by 1 minute. Pressing and holding the button will change the value in the quick mode. If the setting button is not pressed for the next 5 seconds the value will stop flashing and the set time will be saved.

The set time will be counted down by minute during sauna use. When the remaining countdown reaches 5 minutes the unit will release a warning acoustic signal. Now you can set new sauna time. If you do not make a new time setting the sauna will continue working and when the countdown reaches 0 minutes the system will switch off automatically.

4 Temperature display switching between °C and °F

With the sauna on pressing this button will switch between °C/°F temperature values on the TEMPERATURE DISPLAY.

5 Heating Temperature Settings

With the sauna on you can use the + and - (Temperature) buttons to increase or decrease the sauna heating temperature. One depression of the button will increase/decrease the temperature by 1 degree. Pressing and holding the button will change the value in the quick mode. This value will be the sauna temperature setpoint. After 5 seconds of the setting button inactivity the value will stop flashing, the set temperature will be saved and the display will show the current temperature inside the sauna. **Note:** Ambient tempera-

Sauna Control and Operation

ture and the temperature sensor location may cause a difference between the actually measured temperature inside the sauna and the heating temperature set on the control panel amounting up to 5 °C.

6 Heating Start/Stop

With the system on the POWER control below the display is illuminated and if the temperature inside the sauna is lower than the setpoint the HEAT control below the display will illuminate and the heating units will start working.

If you reduce the temperature setpoint by 2 °C below the temperature inside the sauna the heaters will stop heating.

The recommended temperature is 50 °C, in low ambient temperature the heating time is longer.

when the temperature reaches the set value the heaters are switched off and the control of the HEAT

FUNCTION ON THE CONTROL PANEL will go off. After the heater stop the set temperature will be kept inside the sauna for some time. When it drops by 2 °C the heaters will be started again to restore the set temperature.

7 Reading Lamp Switch Inside Sauna

Press the Inside light button once to switch the lamp on and again to switch it off.

8 Roof light switch

Press the roof light switch on the TOP PLATE in front of the front door. Use this switch again to turn it off.

Control Panel Functions



Temperature + / - : temperature setting
Lamp symbol Inside /Outside : press to control the reading lamp or out-door light

°C/°F : press to change the temperature display between °C/°F

Power: Power On/Off

Time +/-: heating time setting

On the left you will see the temperature value (with °C or °F indication next to it), and on the right there is the heating time in minutes. The other three controls signal power on (POWER), heating on (HEAT) and setting function on (SET).

MP3/RADIO REMOTE CONTROL



A. Description of MP3/Radio Control

POW on/off

MODE selector of playing source (radio, USB/SD card, AUX or Bluetooth). If USB/SD is not in the MODE button is used for ending of calls via Bluetooth.

BAND/AMS radio frequency switch button / automatic saving. In the radio mode a short pressing will change the FM/AM frequency band of the radio, and a pressing longer than 2s will start automatic saving of the strongest stations into the device memory - listening to them can be caused by pressing buttons 1-6 of the controller. In the Bluetooth mode the button pressing will answer a call via the connected phone

MUTE pressing this button will mute the sound, to switch the sound on press this button again

▶|| replay start/stop. In the radio mode automatic replaying of the saved stations will start, to end the replay press this button again. In the replaying mode you can start or interrupt replaying.

◀◀▶▶ backward search (previous composition) / forward search (next composition). In the radio mode a short depressing will start automatic forward or backward search of a station, when you press and hold the button for more than 2 seconds you enter the setting mode and can tune up

MP3/RADIO REMOTE CONTROL

the station frequency by short up/down presses. In the replay mode a short pressing will move the replaying to the previous/next composition. Pressing for more than 2 seconds will accelerate forward/backward move along the list of compositions. Another pressing the button will accelerate the search speed even further. To finish search in the list of compositions and start replaying press the **▶||** button.

VOL+/VOL- these buttons are used for volume control. Minimum sound volume is 0, and maximum volume is 40. The default volume after switching on is 16.

IR receiver of infra red signal from remote control

AUX a 3.5mm slot for external device input

USB USB slot

SD SD card slot

B. Remote control description

1: Off/on

2: MODE

3: MUTE

4: BAND

5: VOL+: up key

6: AMS

7: backward station search / previous composition

8: SEL

9: forward station search / next composition

10: EQ

11: VOL-: down key

12: DISP: display

13: replay start/stop

14: after pressing the button for

ca 2 seconds the composition sampling mode will start – now each composition in the inserted medium will play for about 10 seconds – by pressing this button again this mode will be ended

15: after pressing the button for ca 2 seconds the composition repeat mode will start – by pressing this button again this mode will be ended

16: after pressing the button for ca 2 seconds the random composition se-

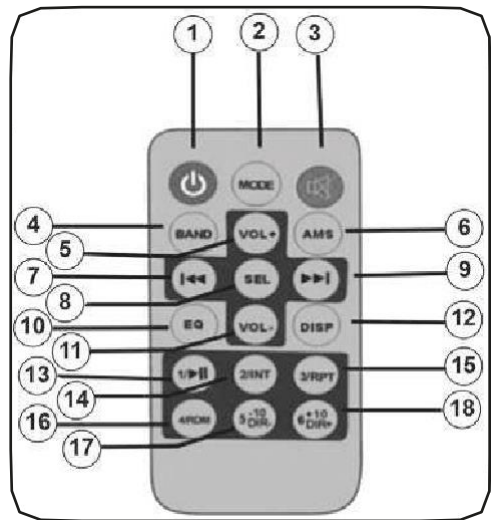

lection mode will start – by pressing this button again this mode will be ended

17: when listening to a composition pressing this button for ca 2 seconds will return the composition listening by 10 back

18: when listening to a composition pressing this button for ca 2 seconds will forward the composition listening by 10 forward

Note: The radio function, or the audio signal quality, may be negatively affected by the simultaneously running ioniser.

WHAT IS INFRA RED RADIATION (IR)

Infra red radiation is electromagnetic wave between the visible light and micro-wave wavelengths. This radiation is similar to sun rays heating our skin by direct IR radiation even in cold days. 95 % of the carbon fibre energy is transformed to long-wave IR waves with wavelength between 5 and 17 microns. The sun generates long-wave infra red waves with the wavelength of 9.4 microns.

Wave (µm)		0.2	0.4	0.75	1000
Gamma ray	X-ray	Ultraviolet	Visible	Infra red	Microwave
Short-wave infra red	Medium-wave infra red	Long-wave infra red		Microwave	
0.75	1.5	5.5		1000	

INFRA RED RADIATION IS SAFE Infra red radiation is vital for nearly all forms of life on our planet. In addition to heating our bodies they can also improve health condition of the body on the cellular level. This technology is safe enough to be used for years in delivery rooms of maternity hospitals where it helps the newborns reach the desired body temperature.

THIS IS NOT THERMAL CHAMBER When people hear the word “sauna” they usually imagine a steam sauna where high temperature and humidity try to force human body to sweat. Steam sauna is similar to conventional stove which boils meals by heating them to extreme temperatures. On the other hand, the infra red sauna rather reminds of a microwave oven generating energy to heat the meal and excite water molecules inside the meal to initiate its cooling. Infra red sauna generates energy heating your body and causing the desired reactions without the need for extreme (and uncomfortable) temperatures inside the cabin. Thanks to the action of infra red rays on the human body sweating inside the infra red sauna starts at much lower temperatures than in the steam sauna.

WHAT HAPPENS INSIDE You will feel the heat generated by the infra red radiators immediately.

The wavelength of this heat lets the rays penetrate your skin and heat your body under its surface. That causes excitation of water molecules in the subcutaneous fat layers causing sweating. Most people tend to start sweating after ca 20 minutes. This time may shorten with more frequent sauna use.

The sweat cause detoxication of the body for the toxic substances excreted by your body from the bloodstream and stored in the fat tissue can get to the skin surface with the sweat. Direct heat also causes widening of your blood vessels (with increased circulation) and acceleration of your breathing and heart frequency. Your body will also burn calories by producing sweat. It is recommended to drink water before, during and after sauna use to prevent body dehydration. Pay attention to what you take with you to your infra red sauna. Some metals absorb infra red radiation and may reach extreme temperature during your stay in the sauna.

HOW TO USE INFRA SAUNA

- 1** You can best use the potential of the infra red therapy when setting the temperature to the top value.
Thus your body will use the full potential of the infra red radiation during your stay in the sauna cabin. If you set the temperature to a lower value the heaters will switch off and on to keep the set temperature. As direct action of the infra red rays is much more effective than the high temperature itself in some cases you may deprive yourself of part of the therapeutic effect of your sauna for some periods of your stay in the cabin. Instead reduction of the set temperature you can regulate the heat inside the sauna by the movable roof ventilation or by letting the door ajar.
- 2** Take a shower and dry your body profoundly before entering the sauna cabin.
Do not use the sauna immediately after intensive physical exercise. Wait
- 3** for at least 15 minutes to permit your body cool down properly.
- 4** Use at least 2-3 towels. Sit on one of the towels folded several times to make a good bottom padding. Place another towel on the floor for sweat absorption and place the third towel on your knees to wipe the sweat. Thus you will support more sweating.
- 5** Take a face cloth with you to wipe your face when you start sweating. A rough face cloth will remove dead face complexion cells and your complexion will be rejuvenated and smoothed. You can do the same on the other parts of your body with a towel, a brush or peeling salt.
- 6** Morning after bedtime is the best time for sauna if you can get up 30 minutes earlier. When you get up, take a few stretching exercises, sweat out in your infra sauna, take a shower and drink a couple of glasses of fresh water. You cannot find a better source of energy for the day. If you have problems with falling asleep use your sauna in the evening. The peace and relaxation inside your sauna will help you fall asleep.
- 7** The best position in the sauna is seating, not lying.
The heaters are placed to provide maximum benefit to a seated person with straight back and feet on the bench level.
- 8** The temperature inside the infra sauna on your entry is irrelevant. You will start sweating after 15 minutes anyway. For that reason you need not wait for the sauna to be fully heated up. The best way is to enter when the sauna starts heating and heat your body together with the sauna cabin.
- 9** It is not recommended to take a shower immediately after exiting the sauna cabin. As your body heated in the cabin you will continue sweating for some time after switching off the heaters, even after leaving the sauna. Sit down in the sauna with the cabin door open and let your body sweat to cool. When you feel pleasant take a lukewarm (not cold) shower to wash the sweat off your body. It is not recommended to use soap after sauna for your

WHAT IS INFRA RED RADIATION (IR)

pores will be open and the soap might obstruct them.

10 It is important to replenish liquids sweated out of your body during your sauna stay. Fresh water is the ideal drink which will not return to the body the calories burnt by sweating.

11 After leaving the sauna remove water and sweat from the cabin inside with a wet cloth (see the following chapter TAKING CARE OF YOUR SAUNA) and leave the door open to ventilate the cabin inside.

TAKING CARE OF YOUR SAUNA

Regular cleaning of your sauna is very important:

sweep or vacuum the floor, including the benches if needed

- ✓ wipe the walls where you touch them - i.e. above the benches, around the door and the control panels

use warm water with a fine soap cleaner and a clean cloth, then wipe with a clean wet cloth

avoid strong cleaners that may stain the wood or even leave traces of chemicals which may release to the air by heat. We recommend to stick to special infra sauna cleaners, such as Saunareiniger

do not use too wet cloth to avoid wood darkening

- ✓ when using your sauna always use a towel for sweat wiping, generally your skin should not be in direct contact with the sauna surface, i.e. the benches, the walls or the backrests

never use steam cleaners, pressure cleaners or water sprays for cleaning your sauna.

never pour water or rinse the infra sauna inside or outside

- ✓ never use dyes or other chemicals to paint the sauna inside, the heat may cause release of vapours from the paint

for wood impregnation of its protection against humidity you can use paraffin

- ✓ oil on the benches and other exposed wooden walls, which will in addition make the natural wood patterns stand out more pronouncedly

BENEFITS OF SAUNA

The benefits of infra red therapy have been studied for several decades in Japan, Europe and since recently also in the United States. The following beneficial effects have been observed in people using infra red sauna regularly:

- ✓ blood pressure reduction
- ✓ joint stiffness reduction
- ✓ weight loss
- ✓ positive effect on the cardiovascular system
- ✓ reduction of blood glucose levels
- ✓ increase of blood circulation
- ✓ reduction of cholesterol and triglyceride levels
- ✓ relief from muscle spasms
- ✓ pain relief
- ✓ energy charging and stress relief
- ✓ increase of body strength and vitality
- ✓ increased extensibility of collagen tissue
- ✓ sauna helped resolve problems of inflammatory infiltrates, oedemas and exudate
- ✓ sauna helped cure acne, eczema, psoriasis, burns, cuts and bruises of the skin
- ✓ sauna helped open wound healing leaving fewer scars
- ✓ sauna improves skin colouration and elasticity
- ✓ sauna helps treat cellulite
- ✓ sauna strengthens the immune system
- ✓ sauna helps reduce injury risk when used for muscle warm up before stretching and exercise
- ✓ sauna detoxicates the body
- ✓ sauna helps treat bronchitis
- ✓ sauna helps treat urticaria, gout, tissue damage and prostate hypertrophy

IMPORTANT WARNING

Infra red radiation emitted by your infra red sauna is recognised as a source with a wide spectrum of potential positive therapeutic effects, as documented by research studies performed in different parts of the world. These benefits are presented here for reference only and do not mean to say that infra red sauna is a source of treatment of any disease. Such conclusions should never be drawn from these statements. If you take prescription drugs, suffer from acute joint disease or have other health problems, consult your doctor before you begin periodic therapy in your infra red sauna. Persons with surgical implants (metal pins, screws, nails, artificial joints, silicon or other implants) usually do not notice any negative effects but they should always consult their attending physicians before commencing their infra red therapy.

HOW IT WORKS

Infra saunas are made with two types of heaters, either ceramic or carbon. Ceramic heaters generate infra red radiation thanks to thin glass tubes strategically distributed across the sauna. The infra red radiation generation generates intense heat and the tubes heat considerably themselves (250-300 °C). They are always protected to prevent their direct contact with the skin. Sauna equipped with ceramic heaters usually heats more quickly than sauna heated with carbon heaters. Their acquisition costs are lower and their life is ca 8000 hours.

A heating unit with carbon fibre comprises a metal incandescence cathode and a carbon fibre. When electric current passes through the metal incandescence cathode the carbon fibre heats and emits long-wave infra red rays. Carbon heaters heat more slowly than ceramic heaters but the infra red radiation distribution is more even and more effective.

Their surface temperature reaches 70-170 °C. The share of infra red waves in the long-wave spectrum is higher than in the case of ceramic heaters and so they are able to penetrate the tissues easily and deeper, which increases the therapeutic effect. Their acquisition costs are a little higher but operation costs are lower and their life is longer, ca 12000 hours.

Ioniser (or negative ion generator) is an instrument using high voltage to ionise (electrically charge) air molecules. Negative ions (anions) are particles with one or more received electrons.

Anions are colourless, odourless and the negatively charged electrons in orbit permits them draw various micro particles from the air.

Anions may thus accumulate and neutralise dust, destroy viruses by the charged electrons, penetrate into microbial cells and destroy them and their negative effects on human health. The more anions in the air, the fewer microbes.

Anions are also called “air vitamins”, “long-life elements” and “air cleaners”. The usable properties of anions were long overlooked. They are very important for human health and we can no longer afford to overlook their curative properties.

The number of anions per one cubic centimetre is as follows:

- ✓ 40 – 50 / cm³ in urban residential areas
- ✓ 100 – 200 / cm³ in urban air
- ✓ 700 – 1,000 / cm³ in open landscape
- ✓ and more than 5,000 / cm³ in mountain valleys and on hillsides.

Human health is directly dependent on anion levels in the air. If anion concentration in the air breathed in by the human body is very low or very high, man begins to breathe spasmodically, can feel fatigue, vertigo, headache or even depression.

Ozone generator attracts a further oxygen atom to the O₂ molecules. In higher concentrations ozone may be toxic for airborne bacteria and can destroy these infectious organisms. Ozone used primarily for destruction of viruses, bacteria and moulds brings versatile benefits to human body – for example blood oxygenation, circulation improvement and oxygen generation stimulation in human tissues. Ozone is also an important immune regulator. For those reasons the spectrum of health problems that can be successfully treated by ozone therapy is broad.

Instruction for use Ionizer and ozone generator may only work separately. When the ozone generator starts work the ionizer is switched off. After 15 minutes the ozone generator is disconnected and the ionizer is switched on automatically. The ionizer is switched on with the “Ion” button, when it is pressed the respective control is illuminated. The ozone generator is switched on with the “O₃” button, when it is pressed the respective control is illuminated and the 15-minute cycle of ozone generation starts running.

TECHNICAL SPECIFICATIONS

Power input	12 V DC
Output	< 5W
Anion generation	100x10 ⁴ pc/cm ³
Ozone generation	≥ 5mg/hr

Warning! Do not touch the HV cable ends with bare hands or metal objects. Otherwise, electric shock may occur.

ERROR LOCALISATION

Problem	Solution
<p>1 Sauna does not work, the control panel does not display anything</p>	<p>1 Check correct connection to power</p> <p>2 Check the switch on the control box (top plate)</p> <p>3 Check connection of the current fuse on the control box (if disconnected press it down)</p>
<p>2 Heaters do not heat</p>	<p>1 Connect the sauna, switch it on and check whether the temperature on the sauna display is the same as the ambient temperature</p> <p>2 If the temperature on the display is the same check whether the temperature setpoint is higher than the ambient temperature</p> <p>3 If this is the case have cable connections and function of the control box checked.</p>
<p>3 Bench heater does not work</p>	<p>1 Check function of the other heaters. If they work check cable connections under the bench</p>
<p>4 The display on the control panel does not show anything</p>	<p>1 Check the control panel for the beep sound after pressing the POWER button</p> <p>2 Check the control unit for the clicking sound after pressing the POWER button</p> <p>3 Check cable plugs for correct connection and securing</p> <p>4 If all 3 points above are OK the control panel needs replacing (if the sauna is equipped with two control panels and only one of them does not work replace the non-functioning control panel)</p> <p>5 if the sounds described under 1 and 2 above cannot be heard the control unit needs replacing</p>
<p>5 The radiator works, the temperature inside the sauna increases but the temperature display does not change</p>	<p>1 Check the temperature sensor for correct position (in the top plate). If the position is correct replace the sensor.</p>

TECHNICAL SPECIFICATIONS

Problem	Solution
6 The display on the control panel only shows part of the text	1 Replace the control panel
7 MP3/radio does not work	1 Check connection of the power cable of the MP3/radio unit, and aerial connection
8 Remote control of MP3/radio does not work	1 Check the remote control battery for correct placement and for discharge 2 Make sure neither the sensor on the remote control nor the sensor on the MP3/radio unit are obstructed
9 One of the loudspeakers does not work	1 Check all cable connectors for getting loose
10 Radio does not work	1 Check the signal in the place of sauna installation (especially in enclosed spaces without windows, such as cellars etc.) 2 Radio signal may be negatively affected by working ionizer - for checking switch the latter off 3 Check correct connection of the aerial to MP3/radio
11 One of the lamps does not illuminate	1 Check the clicking sound of the reading lamp switch on the control panel (if you cannot hear it and the other points are OK the fault is in the control unit and the control unit needs replacing) 2 Check the bulb and replace if necessary 3 Check correct plugging of the lamp (you will need to remove the top cover)

Note: It is recommended to note down the production number of the device for potential warranty claim (the number is written on the sauna REAR PLATE and on the outside package). Do not remove the label with the production number from the device! Tell this number to your distributor for timely and effective service intervention.

SERVICE AND SPARE PARTS

In case you need advice, service support or a spare part, contact your dealer. Use original spare parts for maintenance and repair purposes. Keep this instruction, the warranty certificate and the sales receipt slip. It is recommended to note down the model number and the product number into these documents (see the bottom outer side of the side plate).

Model number	
Production number	

Note: Removal of the production number label may be a reason for warranty complaint rejection.

PACKAGING DISPOSAL

Place the used package to the reserved municipal waste disposal dump.

DISPOSAL OF USED ELECTRIC AND ELECTRONIC EQUIPMENT



Used electric and electronic equipment should not be discarded among communal waste. Observe relevant regulations in force. Protect the environment. Return the non-functional electrical device to your dealer or an authorised collection point for correct disposal or recycling. Remove batteries before returning the device to your dealer.



This product complies with all basic safety and health protection requirements of the applicable EU directives.

INSTRUCTION FOR INSTALLATION AND USE

Infrasauna AMBRE

The pictures show in this handbook need not always correspond to the particular embodiment; their purpose is to assist better understanding of the textual instruction.

The manufacturer and the supplier reserve the right for product changes without the obligation to update this Instruction for Installation and Use.